



The Fristom logo is located in the top right corner. It consists of the word "Fristom" in a white, italicized, sans-serif font, set against a dark blue rectangular background with rounded corners. The background of the entire page features a gradient from dark blue on the left to light blue on the right, with several large, semi-transparent, concentric circles in various shades of blue.

ELECTRICAL 
WIRING
AND LIGHTING SYSTEMS
FOR TRAILERS

A blurred image of a trailer is visible in the lower right portion of the page, showing the front end and wheels, rendered in a light blue, semi-transparent style that blends with the background.

TYP-IA 12V



Electrical 7PIN wire with a fog light from the left side. Other wires lengths are possible to be prepared after consultation.

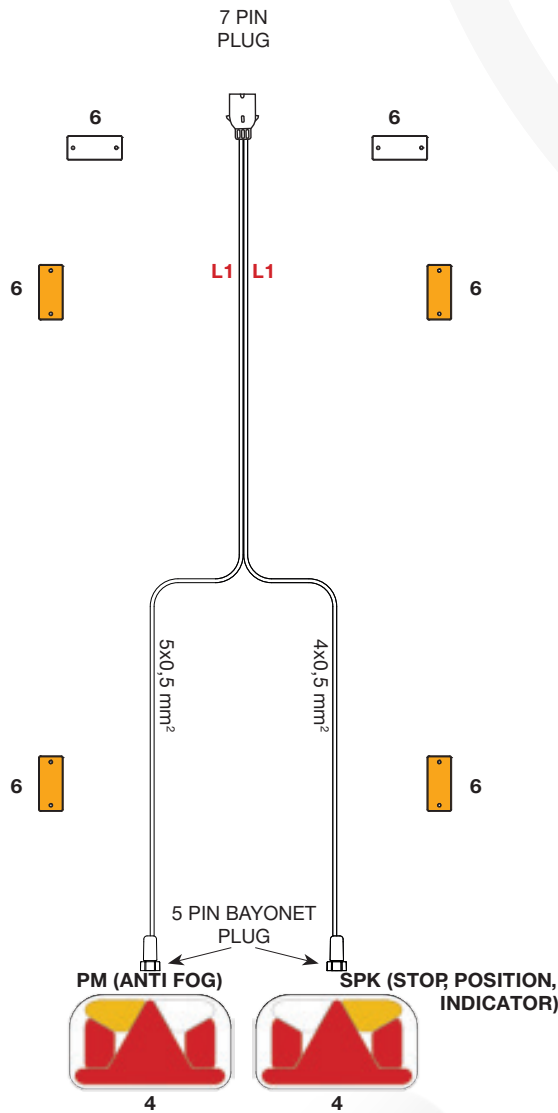

Length L1	Code
3,0 m	IA-030-000
3,5 m	IA-035-000
4,0 m	IA-040-000
4,5 m	IA-045-000
5,0 m	IA-050-000
6,0 m	IA-060-000
7,0 m	IA-070-000
9,0 m	IA-090-000

• The wire length is possible to be customized as required •



XXI 1 - BAJ-005-005



ORDINAL	PRODUCTS	PAGE
6	reflectors - front, side, back	p. 29-30
	triangle reflector	p. 30

LEFT

RIGHT

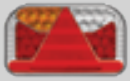

FT-170 L TB LED SPKPN BAJONET 5 PIN



FT-170 P TB LED SPK BAJONET 5 PIN

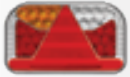

FT-170 L TD LED SPKPN BAJONET 5 PIN

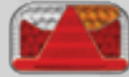

FT-170 P NT LED SPK BAJONET 5 PIN



FT-130 PM LED BAJONET + ▲



FT-130 LED BAJONET PK + ▲



FT-120 T LED BAJONET + FT-123 LED BAJONET
+ XX1 1-BAJ-005-005 + ▲



FT-120 T LED BAJONET + ▲



FT-121 T LED BAJONET + FT-123 LED BAJONET
+ XX1 1-BAJ-005-005 + ▲



FT-121 T LED BAJONET + ▲



FT-122 T LED BAJONET + FT-123 LED BAJONET
+ XX1 1-BAJ-005-005 + ▲



FT-122 T LED BAJONET + ▲



FT-088 LPM BAJONET



FT-088 PMPK BAJONET



MD-036 LPM BAJONET + ▲



MD-036 LPK BAJONET + ▲



MD-002 L BAJONET QS075 +
MD-035 S ZP M03 + ▲



MD-002 L BAJONET + ▲



TYP-IB^{12V}



Electrical 7PIN wire with a fog light from the both sides. Other wires lengths are possible to be prepared after consultation.

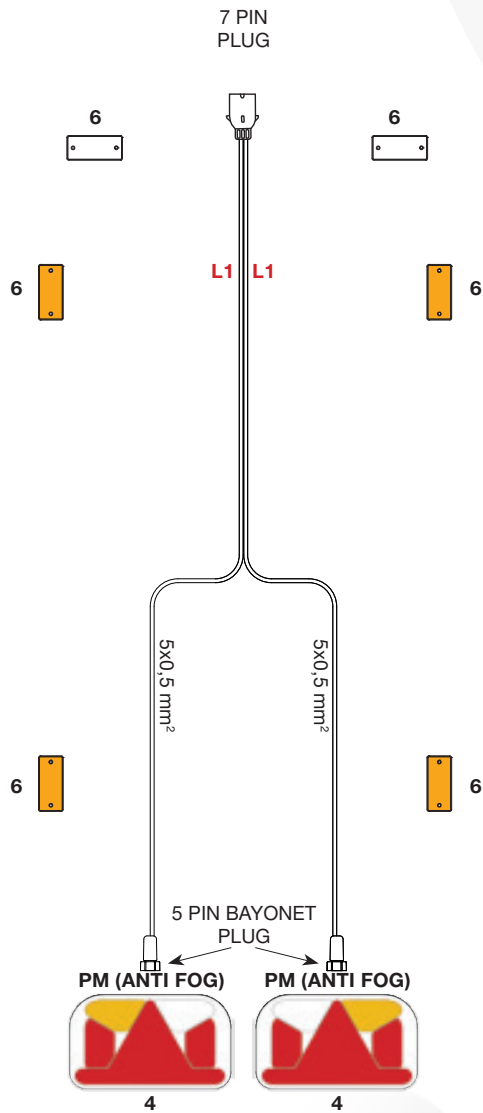

Length L1	Code
3,0 m	IB-030-000
4,0 m	IB-040-000
6,0 m	IB-060-000

• The wire length is possible to be customized as required •



XXI1 - BAJ-005-005



ORDINAL	PRODUCTS	PAGE
6	reflectors - front, side, back	p. 29-30
	triangle reflector	p. 30

LEFT

RIGHT

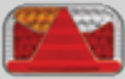

FT-170 L TB LED SPKPN BAJONET 5 PIN

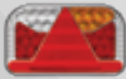

FT-170 P TB LED SPKPM BAJONET 5 PIN

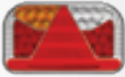

FT-170 L TD LED SPKPN BAJONET 5 PIN

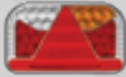

FT-170 P NT LED SPKPM BAJONET 5 PIN



FT-130 PM LED BAJONET + ▲



FT-130 PM LED BAJONET + ▲



FT-120 T LED BAJONET + FT-123 LED BAJONET + XX1 1-BAJ-005-005 + ▲



FT-120 T LED BAJONET + FT-123 LED BAJONET + XX1 1-BAJ-005-005 + ▲



FT-121 T LED BAJONET + FT-123 LED BAJONET + XX1 1-BAJ-005-005 + ▲



FT-121 T LED BAJONET + FT-123 LED BAJONET + XX1 1-BAJ-005-005 + ▲



FT-122 T LED BAJONET + FT-123 LED BAJONET + XX1 1-BAJ-005-005 + ▲



FT-122 T LED BAJONET + FT-123 LED BAJONET + XX1 1-BAJ-005-005 + ▲



FT-088 LPM BAJONET



FT-088 PPM BAJONET



MD-036 L BAJONET + ▲



MD-036 L BAJONET + ▲



MD-002 L BAJONET QS075 + MD-035 S ZP M03 + ▲



MD-002 L BAJONET QS075 + MD-035 S ZP M03 + ▲

TYP-IC^{12V}



Electrical 7PIN wire. Other wires lengths are possible to be prepared after consultation.

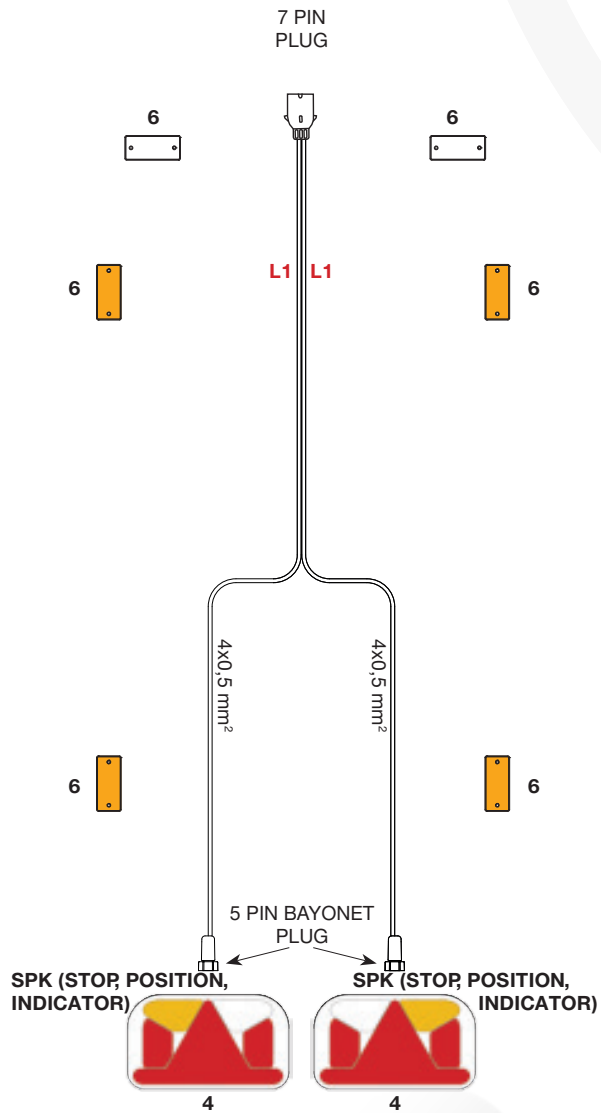

Length L1	Code
1,5 m	IC-015-000

• The wire length is possible to be customized as required •



ORDINAL	PRODUCTS	PAGE
6	reflectors - front, side, back	p. 29-30
	triangle reflector	p. 30

LEFT

RIGHT



FT-170 L TB LED SPK BAJONET 5 PIN

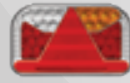

FT-170 P TB LED SPK BAJONET 5 PIN



FT-170 L TD LED SPK BAJONET 5 PIN



FT-170 P NT LED SPK BAJONET 5 PIN



FT-130 PK LED BAJONET + ▲



FT-130 PK LED BAJONET PK + ▲



FT-120 T LED BAJONET + ▲



FT-120 T LED BAJONET + ▲



FT-121 T LED BAJONET + ▲



FT-121 T LED BAJONET + ▲



FT-122 T LED BAJONET + ▲



FT-122 T LED BAJONET + ▲



MD-036 L PK BAJONET + ▲



MD-036 L PK BAJONET + ▲



MD-002 L BAJONET + ▲



MD-002 L BAJONET + ▲



TYP-IIA^{12V}



Electrical 7PIN wire with a fog light from the left side. Other wires lengths are possible to be prepared after consultation.

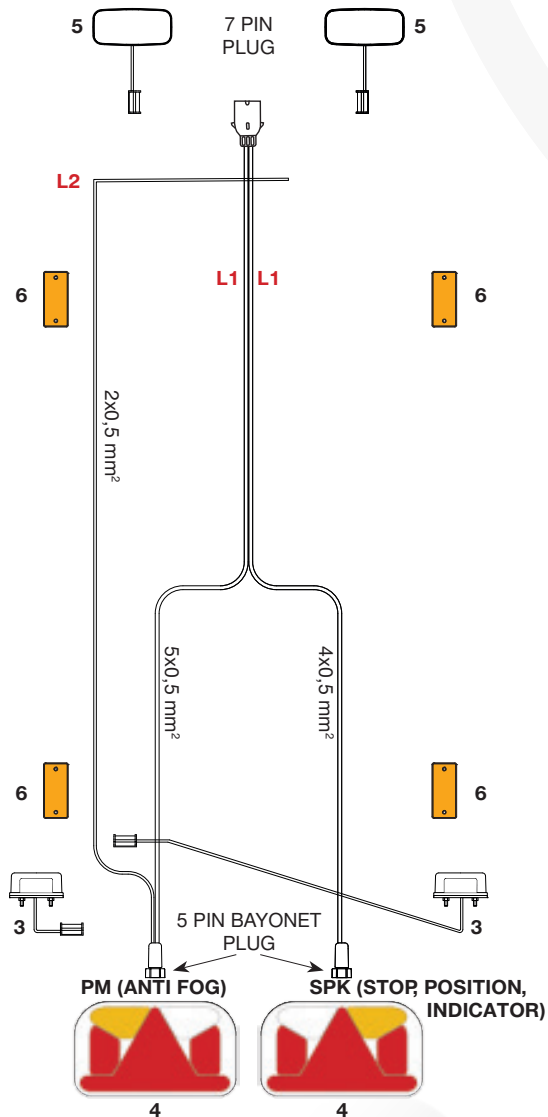

Length L1	Length L2	Code
3,5 m	2,0 m	IIA-035-020
4,0 m	3,0 m	IIA-040-030
4,6 m	3,5 m	IIA-046-035
5,0 m	4,0 m	IIA-050-040
5,5 m	4,5 m	IIA-055-045
6,0 m	5,0 m	IIA-060-050

• The wire length is possible to be customized as required •



XXI 1 – BAJ-005-005



ORDINAL	PRODUCTS	PAGE
6	reflectors – front, side, back triangle reflector	p. 29-30 p. 30
3	number plate lights	p. 28
5	front clearance lights	p. 25

LEFT

RIGHT

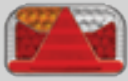

FT-170 L TB LED SPKPM BAJONET 5 PIN



FT-170 P TB LED SPK BAJONET 5 PIN

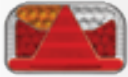

FT-170 L TD LED SPKPM BAJONET 5 PIN

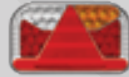

FT-170 P NT LED SPK BAJONET 5 PIN



FT-130 PM LED BAJONET + ▲



FT-130 PK LED BAJONET PK + ▲



FT-120 T LED BAJONET + FT-123 LED BAJONET
+ XX1 1-BAJ-005-005 + ▲



FT-120 T LED BAJONET + ▲



FT-121 T LED BAJONET + FT-123 LED BAJONET
+ XX1 1-BAJ-005-005 + ▲



FT-121 T LED BAJONET + ▲



FT-122 T LED BAJONET + FT-123 LED BAJONET
+ XX1 1-BAJ-005-005 + ▲



FT-122 T LED BAJONET + ▲



FT-088 LPM BAJONET



FT-088 PPM PK BAJONET



MD-036 L BAJONET + ▲



MD-036 L PK BAJONET + ▲



MD-002 L BAJONET QS075
MD-035 S ZP M03 + ▲



MD-002 L BAJONET + ▲



FT-077 LPM BAJONET + number plate light



FT-077 PPM PK BAJONET + number plate light



FT-170 L NT LED SPKPM BAJONET 5 PIN
+ number plate light



FT-170 P NT LED SPK BAJONET 5 PIN
+ number plate light



FT-130 NT PM LED BAJONET + ▲
+ number plate light



FT-130 NT LED BAJONET PK + ▲
+ number plate light



FT-120 LED BAJONET + FT-123 LED BAJONET
+ XX1 1-BAJ-005-005 + ▲ + number plate light



FT-120 LED BAJONET + ▲ + number plate light



FT-121 LED BAJONET + FT-123 LED BAJONET
+ XX1 1-BAJ-005-005 + ▲ + number plate light



FT-121 LED BAJONET + ▲ + number plate light



FT-122 LED BAJONET + FT-123 LED BAJONET
+ XX1 1-BAJ-005-005 + ▲ + number plate light



FT-122 LED BAJONET + ▲ + number plate light



FT-110 LED BAJONET + FT-111 LED BAJONET
+ XX1 1-BAJ-005-005 + ▲ + number plate light



FT-110 LED BAJONET + ▲ + number plate light



FT-113 LED BAJONET + FT-111 LED BAJONET
+ XX1 1-BAJ-005-005 + ▲ + number plate light



FT-113 LED BAJONET + ▲ + number plate light

TYP-IIB^{12V}

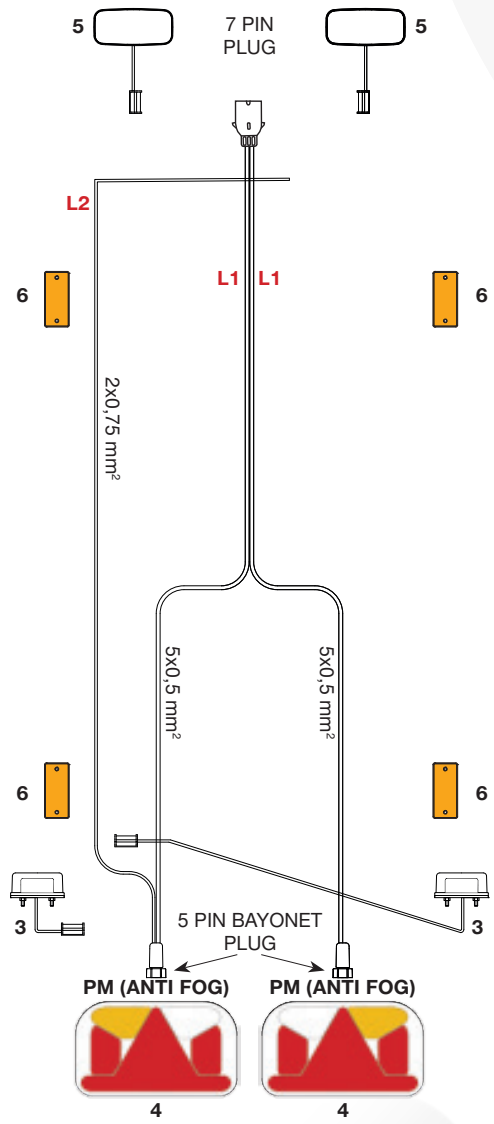

Electrical 7PIN wire with a fog light from both sides. Other wires lengths are possible to be prepared after consultation.

Length L1	Length L2	Code
4,0 m	3,0 m	IIB-040-030
7,5 m	7,0 m	IIB-075-070

• The wire length is possible to be customized as required •



XXI 1 - BAJ-005-005



ORDINAL	PRODUCTS	PAGE
6	reflectors - front, side, back triangle reflector	p. 29-30 p. 30
3	number plate lights	p. 28
5	front clearance lights	p. 25

LEFT

RIGHT

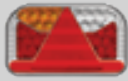

FT-170 L TB LED SPKPM BAJONET 5PIN

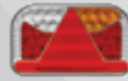

FT-170 P TB LED SPKPM BAJONET 5PIN

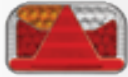

FT-170 L TD LED SPKPM BAJONET 5PIN

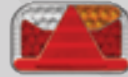

FT-170 P NT LED SPKPM BAJONET 5PIN



FT-130 PM LED BAJONET + ▲



FT-130 PM LED BAJONET + ▲



FT-120 T LED BAJONET + FT-123 LED BAJONET
+ XXI 1-BAJ-005-005 + ▲



FT-120 T LED BAJONET + FT-123 LED BAJONET
+ XXI 1-BAJ-005-005 + ▲



FT-121 T LED BAJONET + FT-123 LED BAJONET
+ XXI 1-BAJ-005-005 + ▲



FT-121 T LED BAJONET + FT-123 LED BAJONET
+ XXI 1-BAJ-005-005 + ▲



FT-122 T LED BAJONET + FT-123 LED BAJONET
+ XXI 1-BAJ-005-005 + ▲



FT-122 T LED BAJONET + FT-123 LED BAJONET
+ XXI 1-BAJ-005-005 + ▲



FT-088 L PM BAJONET



FT-088 PPM BAJONET



MD-036 L BAJONET + ▲



MD-036 L BAJONET + ▲



MD-002 L BAJONET QS075
+ MD-035 S ZP M03 + ▲



MD-002 L BAJONET QS075
+ MD-035 S ZP M03 + ▲



FT-077 LPM BAJONET + number plate light



FT-077 PPM BAJONET + number plate light

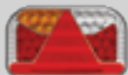

FT-170 NT LED SPKPM BAJONET 5PIN
+ number plate light



FT-170 P NT LED SPKPM BAJONET 5PIN
+ number plate light



FT-130 NT PM BAJONET + ▲
+ number plate light



FT-130 NT PM BAJONET + ▲
+ number plate light



FT-120 LED BAJONET + FT-123 LED BAJONET
+ XXI 1-BAJ-005-005 + ▲ + number plate light



FT-120 LED BAJONET + FT-123 LED BAJONET
+ XXI 1-BAJ-005-005 + ▲ + number plate light



FT-121 LED BAJONET + FT-123 LED BAJONET
+ XXI 1-BAJ-005-005 + ▲ + number plate light



FT-121 LED BAJONET + FT-123 LED BAJONET
+ XXI 1-BAJ-005-005 + ▲ + number plate light



FT-122 LED BAJONET + FT-123 LED BAJONET
+ XXI 1-BAJ-005-005 + ▲ + number plate light



FT-122 LED BAJONET + FT-123 LED BAJONET
+ XXI 1-BAJ-005-005 + ▲ + number plate light



FT-110 LED BAJONET + FT-111 LED BAJONET
+ XXI 1-BAJ-005-005 + ▲ + number plate light



FT-110 LED BAJONET + FT-111 LED BAJONET
+ XXI 1-BAJ-005-005 + ▲ + number plate light



FT-113 LED BAJONET + FT-111 LED BAJONET
+ XXI 1-BAJ-005-005 + ▲ + number plate light



FT-113 LED BAJONET + FT-111 LED BAJONET
+ XXI 1-BAJ-005-005 + ▲ + number plate light

TYP-III A^{12V}



Electrical 7PIN wire with a fog light from the left side. Other wires lengths are possible to be prepared after consultation.

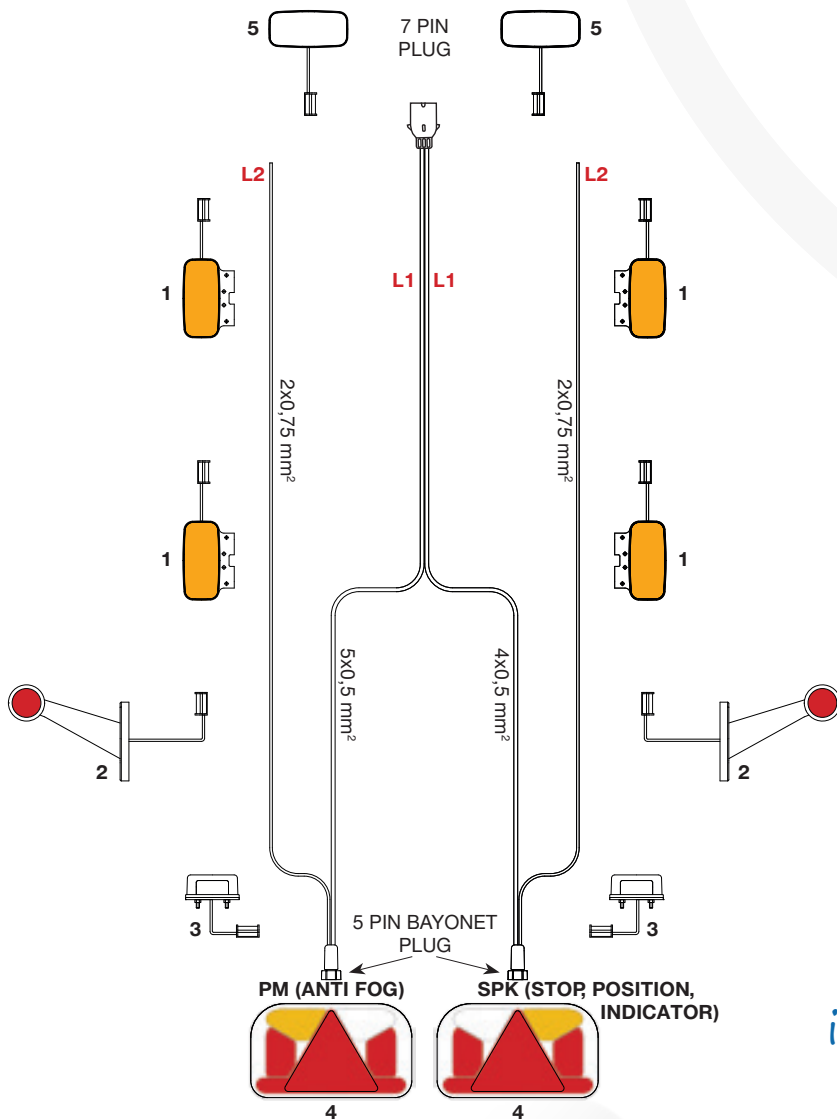

Length L1	Length L2	Code
3,5 m	1,0 m	IIIA-035-010
4,0 m	2,0 m	IIIA-040-020
4,5 m	2,5 m	IIIA-045-025
5,0 m	3,1 m	IIIA-050-031
6,0 m	4,6 m	IIIA-060-046
6,5 m	4,1 m	IIIA-065-041
7,0 m	5,5 m	IIIA-070-055
7,1 m	4,8 m	IIIA-071-048
8,0 m	6,0 m	IIIA-080-060
9,0 m	7,8 m	IIIA-090-078
11,5 m	8,1 m	IIIA-115-081

• The wire length is possible to be customized as required •



XXI 1 - BAJ-005-005



ORDINAL	PRODUCTS	PAGE
5	front clearance lights	p. 25
1	side clearance lights	p. 26
2	side markers	p. 27
3	number plate lights	p. 28

LEFT

RIGHT

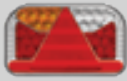

FT-170 L TB LED SPKPM BAJONET 5PIN

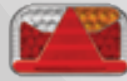

FT-170 P TB LED SPK BAJONET 5PIN

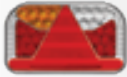

FT-170 L TD LED SPKPM BAJONET 5PIN

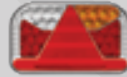

FT-170 P NT LED SPK BAJONET 5PIN



FT-130 PM LED BAJONET + ▲



FT-130 P LED BAJONET PK + ▲



FT-120 T LED BAJONET + FT-123 LED BAJONET
+ XXI 1-BAJ-005-005 + ▲



FT-120 T LED BAJONET + ▲



FT-121 T LED BAJONET + FT-123 LED BAJONET
+ XXI 1-BAJ-005-005 + ▲



FT-121 T LED BAJONET + ▲



FT-122 T LED BAJONET + FT-123 LED BAJONET
+ XXI 1-BAJ-005-005 + ▲



FT-122 T LED BAJONET + ▲



FT-088 L PM BAJONET



FT-088 PPM BAJONET PK



MD-036 L BAJONET + ▲



MD-036 L BAJONET PK + ▲



MD-002 L BAJONET QS075
+ MD-035 S ZP M03 + ▲



MD-002 L BAJONET + ▲



FT-077 LPM BAJONET + number plate light



FT-077 PPM PK BAJONET + number plate light



FT-170 NT LED SPKPM BAJONET 5PIN
+ number plate light



FT-170 P NT LED SPK BAJONET 5PIN
+ number plate light



FT-130 NT PM BAJONET + ▲
+ number plate light



FT-130 NT BAJONET PK + ▲
+ number plate light



FT-120 LED BAJONET + FT-123 LED BAJONET
+ XXI 1-BAJ-005-005 + ▲ + number plate light



FT-120 LED BAJONET + ▲ + number plate light



FT-121 LED BAJONET + FT-123 LED BAJONET
+ XXI 1-BAJ-005-005 + ▲ + number plate light



FT-121 LED BAJONET + ▲ + number plate light



FT-122 LED BAJONET + FT-123 LED BAJONET
+ XXI 1-BAJ-005-005 + ▲ + number plate light



FT-122 LED BAJONET + ▲ + number plate light



FT-110 LED BAJONET + FT-111 LED BAJONET
+ XXI 1-BAJ-005-005 + ▲ + number plate light



FT-110 LED BAJONET + ▲ + number plate light



FT-113 LED BAJONET + FT-111 LED BAJONET
+ XXI 1-BAJ-005-005 + ▲ + number plate light



FT-113 LED BAJONET + ▲ + number plate light

TYP-III B^{12V}



Electrical 7PIN wire with a fog light from both sides. Other wires lengths are possible to be prepared after consultation.

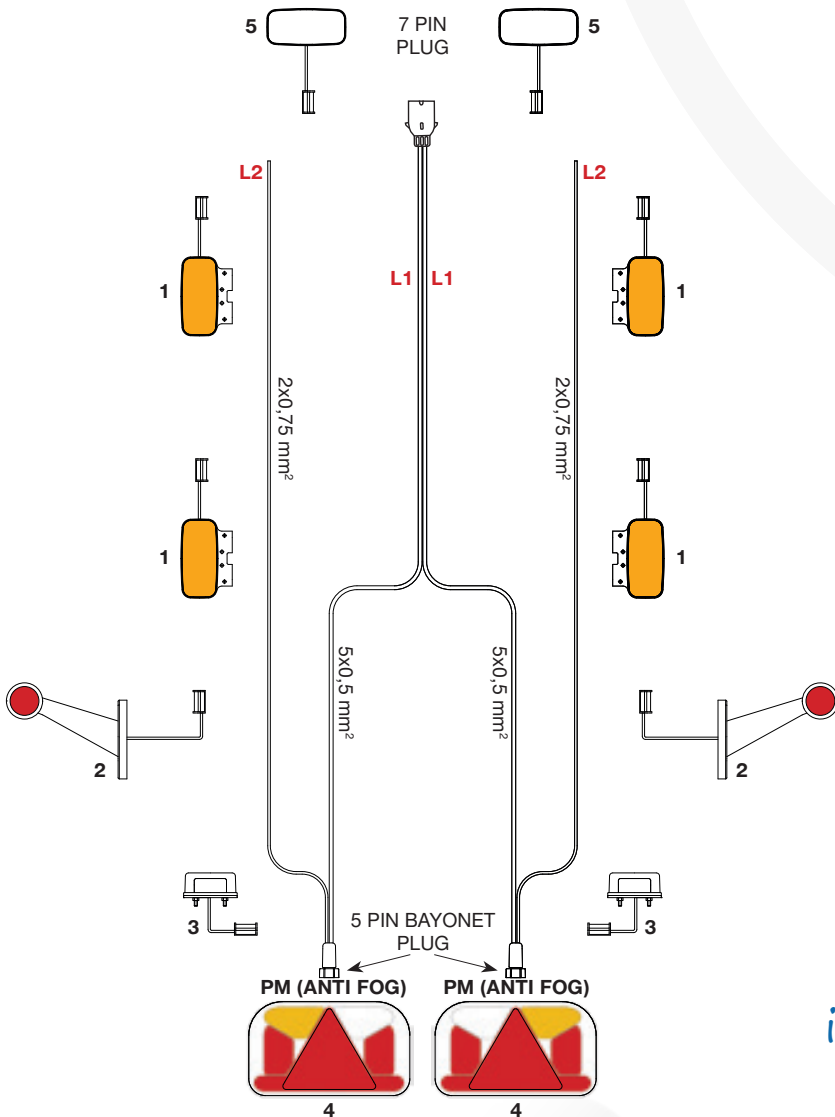

Length L1	Length L2	Code
5,0 m	4,5 m	IIIB-050-045
6,0 m	5,5 m	IIIB-060-055
7,0 m	6,5 m	IIIB-070-065
8,0 m	7,5 m	IIIB-080-075

• The wire length is possible to be customized as required.



XXI 1 - BAJ-005-005



ORDINAL	PRODUCTS	PAGE
5	front clearance lights	p. 25
1	side clearance lights	p. 26
2	side markers	p. 27
3	number plate lights	p. 28

LEFT

RIGHT

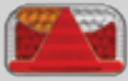

FT-170 L TB LED SPKPM BAJONET 5PIN



FT-170 P TB LED SPKPM BAJONET 5PIN

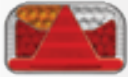

FT-170 L TD LED SPKPM BAJONET 5PIN

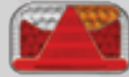

FT-170 P NT LED SPKPM BAJONET 5PIN



FT-130 PM LED BAJONET + ▲



FT-130 PM LED BAJONET + ▲



FT-120 T LED BAJONET + FT-123 LED BAJONET
+ XXI 1-BAJ-005-005 + ▲



FT-120 T LED BAJONET + FT-123 LED BAJONET
+ XXI 1-BAJ-005-005 + ▲



FT-121 T LED BAJONET + FT-123 LED BAJONET
+ XXI 1-BAJ-005-005 + ▲



FT-121 T LED BAJONET + FT-123 LED BAJONET
+ XXI 1-BAJ-005-005 + ▲



FT-122 T LED BAJONET + FT-123 LED BAJONET
+ XXI 1-BAJ-005-005 + ▲



FT-122 T LED BAJONET + FT-123 LED BAJONET
+ XXI 1-BAJ-005-005 + ▲



FT-088 L PM BAJONET



FT-088 PPM BAJONET PK



MD-036 L BAJONET + ▲



MD-036 L BAJONET + ▲



MD-002 L BAJONET QS075
+ MD-035 S ZP M03 + ▲



MD-002 L BAJONET QS075
+ MD-035 S ZP M03 + ▲



FT-077 LPM BAJONET + number plate light



FT-077 PPM BAJONET + number plate light

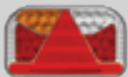

FT-170 NT LED SPKPM BAJONET 5PIN
+ number plate light

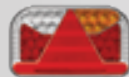

FT-170 P NT LED SPKPM BAJONET 5PIN
+ number plate light



FT-130 NT PM BAJONET + ▲
+ number plate light



FT-130 NT PM BAJONET + ▲
+ number plate light



FT-120 LED BAJONET + FT-123 LED BAJONET
+ XXI 1-BAJ-005-005 + ▲ + number plate light



FT-120 LED BAJONET + FT-123 LED BAJONET
+ XXI 1-BAJ-005-005 + ▲ + number plate light



FT-121 LED BAJONET + FT-123 LED BAJONET
+ XXI 1-BAJ-005-005 + ▲ + number plate light



FT-121 LED BAJONET + FT-123 LED BAJONET
+ XXI 1-BAJ-005-005 + ▲ + number plate light



FT-122 LED BAJONET + FT-123 LED BAJONET
+ XXI 1-BAJ-005-005 + ▲ + number plate light



FT-122 LED BAJONET + FT-123 LED BAJONET
+ XXI 1-BAJ-005-005 + ▲ + number plate light



FT-110 LED BAJONET + FT-111 LED BAJONET
+ XXI 1-BAJ-005-005 + ▲ + number plate light



FT-110 LED BAJONET + FT-111 LED BAJONET
+ XXI 1-BAJ-005-005 + ▲ + number plate light



FT-113 LED BAJONET + FT-111 LED BAJONET
+ XXI 1-BAJ-005-005 + ▲ + number plate light



FT-113 LED BAJONET + FT-111 LED BAJONET
+ XXI 1-BAJ-005-005 + ▲ + number plate light

TYP-IV^{12V}



Electrical 13PIN wire with a fog light from the left side and a reversing light from the right side. Other wires lengths are possible to be prepared after consultation.

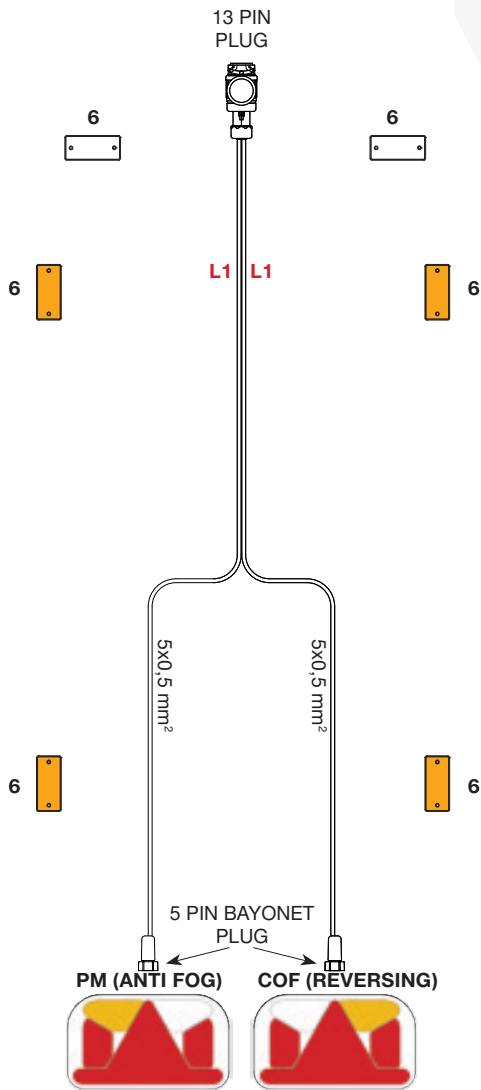

Length L1	Code
1,5 m	IV-015-000
4,0 m	IV-040-000
5,0 m	IV-050-000
7,0 m	IV-070-000
9,0 m	IV-090-000

• The wire length is possible to be customized as required.



XXI 1 - BAJ-005-005



ORDINAL	PRODUCTS	PAGE
6	reflectors - front, side, back	p. 29-30
	triangle reflector	p. 30

LEFT

RIGHT

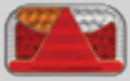

FT-170 L TB LED SPKPM BAJONET 5PIN



FT-170 P TB LED SPKCOF BAJONET 5PIN

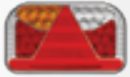

FT-170 L TD LED SPKPM BAJONET 5PIN

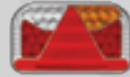

FT-170 P NT LED SPKCOF BAJONET 5PIN



FT-130 PM LED BAJONET + ▲



FT-130 COF LED BAJONET + ▲



FT-120 T LED BAJONET + FT-123 LED BAJONET
+ XXI 1-BAJ-005-005 + ▲



FT-120 T LED BAJONET + FT-124 LED BAJONET
+ XXI 1-BAJ-005-005 + ▲



FT-121 T LED BAJONET + FT-123 LED BAJONET
+ XXI 1-BAJ-005-005 + ▲



FT-121 T LED BAJONET + FT-124 LED BAJONET
+ XXI 1-BAJ-005-005 + ▲



FT-122 T LED BAJONET + FT-123 LED BAJONET
+ XXI 1-BAJ-005-005 + ▲



FT-122 T LED BAJONET + FT-124 LED BAJONET
+ XXI 1-BAJ-005-005 + ▲



FT-088 L PM BAJONET



FT-088 PCOF BAJONET



MD-036 L BAJONET + ▲



MD-036 P BAJONET + ▲



MD-002 L BAJONET QS075
+ MD-035 S ZP M03 + ▲



MD-002 L BAJONET QS075
+ MD-040 S ZP M03 + ▲

TYP-V^{12V}



Electrical 13PIN wire with a fog light from the left side and a reversing light from the right side. Other wires lengths are possible to be prepared after consultation.

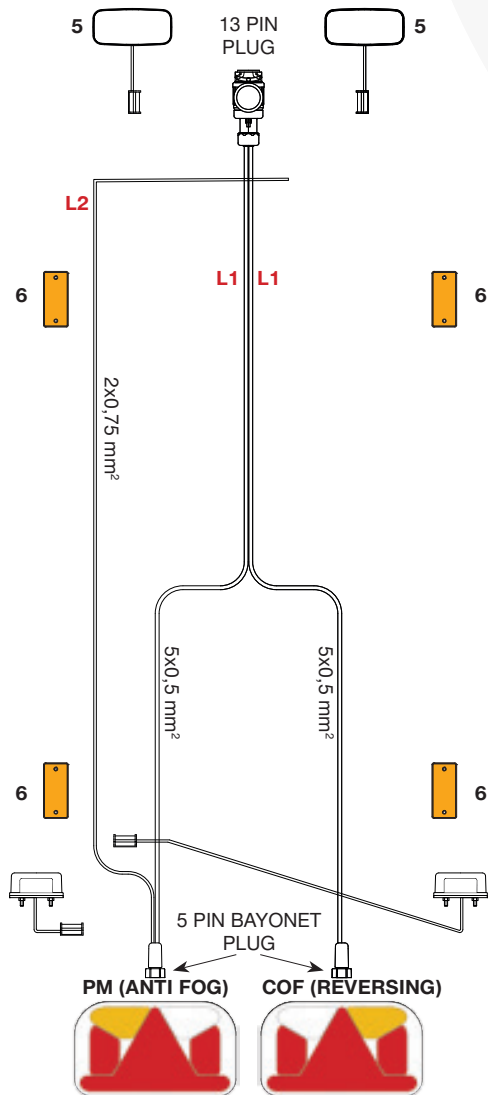

Length L1	Length L2	Code
4,0 m	3,0 m	V-040-030
4,5 m	3,5 m	V-045-035
5,0 m	4,0 m	V-050-040
6,0 m	5,0 m	V-060-050
7,0 m	6,0 m	V-070-060
7,5 m	6,5 m	V-075-065

• The wire length is possible to be customized as required.



XXI1 - BAJ-005-005



ORDINAL	PRODUCTS	PAGE
6	reflectors - front, side, back triangle reflector	p. 29-30 p. 30
3	number plate lights	p. 28
5	front clearance light	p. 25

LEFT

RIGHT

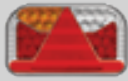

FT-170 L TB LED SPKPM BAJONET 5PIN

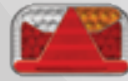

FT-170 P TB LED SPKCOF BAJONET 5PIN

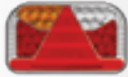

FT-170 L TD LED SPKPM BAJONET 5PIN

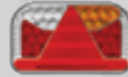

FT-170 P NT LED SPKCOF BAJONET 5PIN



FT-130 PM LED BAJONET + ▲



FT-130 COF LED BAJONET + ▲



FT-120 T LED BAJONET + FT-123 LED BAJONET + XXI 1-BAJ-005-005 + ▲



FT-120 T LED BAJONET + FT-124 LED BAJONET + XXI 1-BAJ-005-005 + ▲



FT-121 T LED BAJONET + FT-123 LED BAJONET + XXI 1-BAJ-005-005 + ▲



FT-121 T LED BAJONET + FT-124 LED BAJONET + XXI 1-BAJ-005-005 + ▲



FT-122 T LED BAJONET + FT-123 LED BAJONET + XXI 1-BAJ-005-005 + ▲



FT-122 T LED BAJONET + FT-124 LED BAJONET + XXI 1-BAJ-005-005 + ▲



FT-088 L PM BAJONET



FT-088 PCOF BAJONET



MD-036 L BAJONET + ▲



MD-036 P BAJONET + ▲



MD-002 L BAJONET QS075 + MD-035 S ZP M03 + ▲



MD-002 L BAJONET QS075 + MD-040 S ZP M03 + ▲



FT-077 LPM BAJONET + number plate light



FT-077 PCOF BAJONET + number plate light

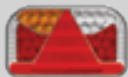

FT-170 NT LED SPKPM BAJONET 5PIN + number plate light

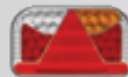

FT-170 P NT LED SPKCOF BAJONET 5PIN + number plate light



FT-130 NT PM BAJONET + ▲ + number plate light



FT-130 NT COF BAJONET + ▲ + number plate light



FT-120 LED BAJONET + FT-123 LED BAJONET + XXI 1-BAJ-005-005 + ▲ + number plate light



FT-120 LED BAJONET + FT-124 LED BAJONET + XXI 1-BAJ-005-005 + ▲ + number plate light



FT-121 LED BAJONET + FT-123 LED BAJONET + XXI 1-BAJ-005-005 + ▲ + number plate light



FT-121 LED BAJONET + FT-124 LED BAJONET + XXI 1-BAJ-005-005 + ▲ + number plate light



FT-122 LED BAJONET + FT-123 LED BAJONET + XXI 1-BAJ-005-005 + ▲ + number plate light



FT-122 LED BAJONET + FT-124 LED BAJONET + XXI 1-BAJ-005-005 + ▲ + number plate light



FT-110 LED BAJONET + FT-111 LED BAJONET + XXI 1-BAJ-005-005 + ▲ + number plate light



FT-110 LED BAJONET + FT-112 LED BAJONET + XXI 1-BAJ-005-005 + ▲ + number plate light



FT-113 LED BAJONET + FT-111 LED BAJONET + XXI 1-BAJ-005-005 + ▲ + number plate light



FT-113 LED BAJONET + FT-112 LED BAJONET + XXI 1-BAJ-005-005 + ▲ + number plate light

TYP-VI 12V



Electrical 13PIN wire with a fog light from the left side and a reversing light from the right side. Other wires lengths are possible to be prepared after consultation.

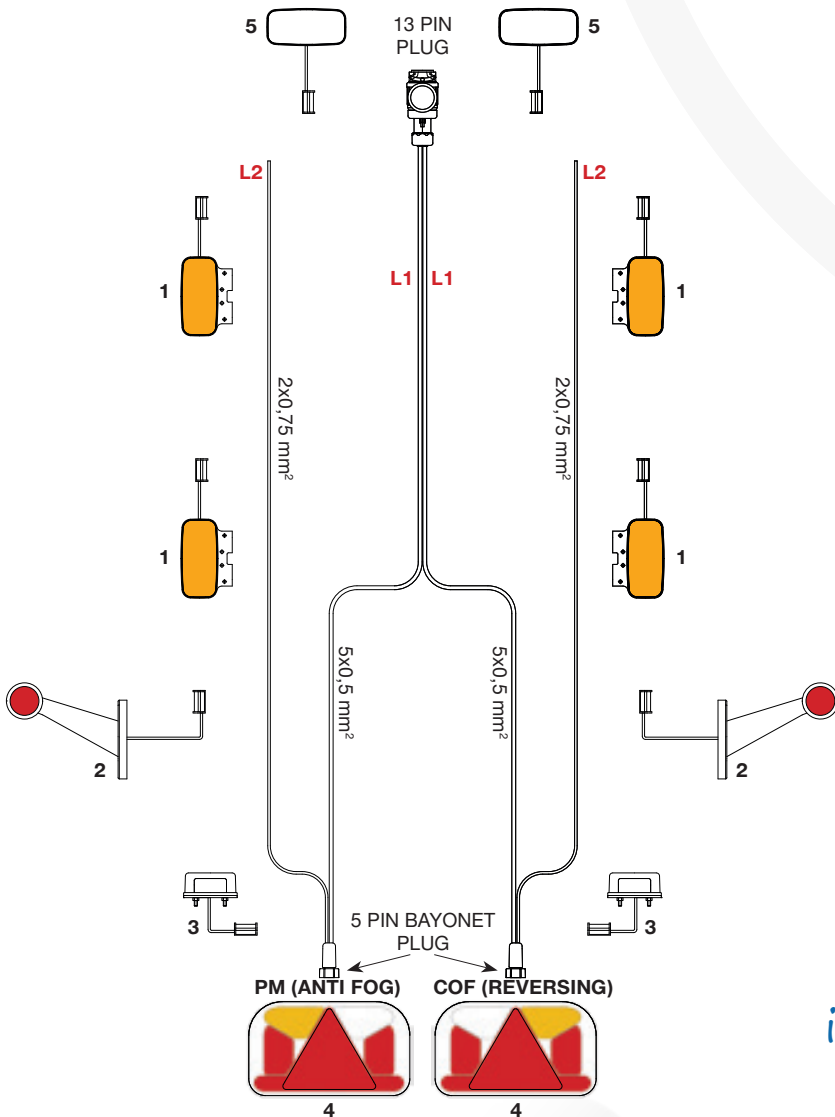

Length L1	Length L2	Code
5,0 m	3,1 m	VI-050-031
5,5 m	3,1 m	VI-055-031
6,0 m	4,6 m	VI-060-046
6,5 m	4,1 m	VI-065-041
7,5 m	0,5 m	VI-075-005
7,7 m	5,3 m	VI-077-053
9,0 m	6,5 m	VI-090-065
10,5 m	8,1 m	VI-105-081
11,5 m	8,1 m	VI-115-081

• The wire length is possible to be customized as required.



XXI1 - BAJ-005-005



ORDINAL	PRODUCTS	PAGE
5	front clearance light	p. 25
1	side clearance light	p. 26
2	side markers	p. 27
3	number plate light	p. 28

LEFT

RIGHT

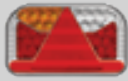

FT-170 L TB LED SPKPM BAJONET 5PIN



FT-170 P TB LED SPKCOF BAJONET 5PIN

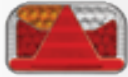

FT-170 L TD LED SPKPM BAJONET 5PIN

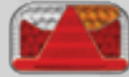

FT-170 P NT LED SPKCOF BAJONET 5PIN



FT-130 PM LED BAJONET + ▲



FT-130 COF LED BAJONET + ▲



FT-120 T LED BAJONET + FT-123 LED BAJONET + XXI 1-BAJ-005-005 + ▲



FT-120 T LED BAJONET + FT-124 LED BAJONET + XXI 1-BAJ-005-005 + ▲



FT-121 T LED BAJONET + FT-123 LED BAJONET + XXI 1-BAJ-005-005 + ▲



FT-121 T LED BAJONET + FT-124 LED BAJONET + XXI 1-BAJ-005-005 + ▲



FT-122 T LED BAJONET + FT-123 LED BAJONET + XXI 1-BAJ-005-005 + ▲



FT-122 T LED BAJONET + FT-124 LED BAJONET + XXI 1-BAJ-005-005 + ▲



FT-088 L PM BAJONET



FT-088 PCOF BAJONET



MD-036 L BAJONET + ▲



MD-036 P BAJONET + ▲



MD-002 L BAJONET QS075 + MD-035 S ZP M03 + ▲



MD-002 L BAJONET QS075 + MD-040 S ZP M03 + ▲



FT-077 LPM BAJONET + number plate light



FT-077 PCOF BAJONET + number plate light

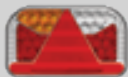

FT-170 NT LED SPKPM BAJONET 5PIN + number plate light

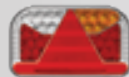

FT-170 P NT LED SPKCOF BAJONET 5PIN + number plate light



FT-130 NT PM BAJONET + ▲ + number plate light



FT-130 NT COF BAJONET + ▲ + number plate light



FT-120 LED BAJONET + FT-123 LED BAJONET + XXI 1-BAJ-005-005 + ▲ + number plate light



FT-120 LED BAJONET + FT-124 LED BAJONET + XXI 1-BAJ-005-005 + ▲ + number plate light



FT-121 LED BAJONET + FT-123 LED BAJONET + XXI 1-BAJ-005-005 + ▲ + number plate light



FT-121 LED BAJONET + FT-124 LED BAJONET + XXI 1-BAJ-005-005 + ▲ + number plate light



FT-122 LED BAJONET + FT-123 LED BAJONET + XXI 1-BAJ-005-005 + ▲ + number plate light



FT-122 LED BAJONET + FT-124 LED BAJONET + XXI 1-BAJ-005-005 + ▲ + number plate light



FT-110 LED BAJONET + FT-111 LED BAJONET + XXI 1-BAJ-005-005 + ▲ + number plate light



FT-110 LED BAJONET + FT-112 LED BAJONET + XXI 1-BAJ-005-005 + ▲ + number plate light



FT-113 LED BAJONET + FT-111 LED BAJONET + XXI 1-BAJ-005-005 + ▲ + number plate light



FT-113 LED BAJONET + FT-112 LED BAJONET + XXI 1-BAJ-005-005 + ▲ + number plate light

TYP-XXII3-GN-12V

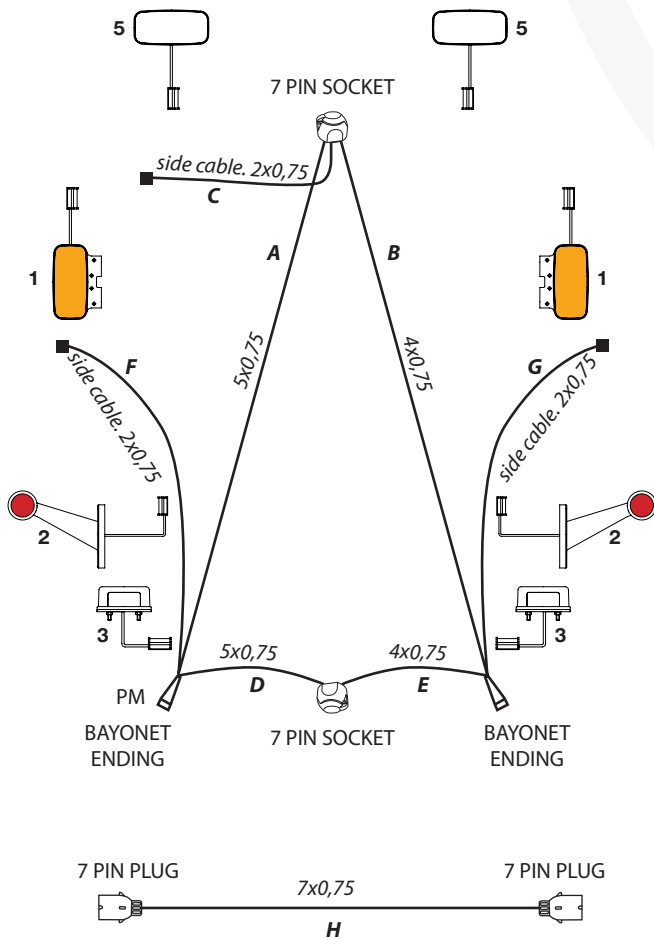

Code	XXII3-GN-
	Length
A	
B	
C	
D	
E	
F	
G	
Code	WTY 7 PIN - ...- WTY 7 PIN
H	

• The wire length is possible to be customized as required •



XXI 1 - BAJ-005-005



ORDINAL	PRODUCTS	PAGE
5	front clearance lights	p. 25
1	side clearance lights	p. 26
2	side markers	p. 27
3	number plate lights	p. 28

LEFT

RIGHT

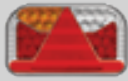

FT-170 L TB LED SPKPM BAJONET 5PIN

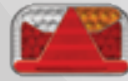

FT-170 P TB LED SPK BAJONET 5PIN

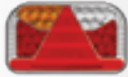

FT-170 L TD LED SPKPM BAJONET 5PIN

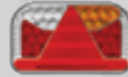

FT-170 P NT LED SPK BAJONET 5PIN



FT-130 PM LED BAJONET + ▲



FT-130 PK LED BAJONET + ▲



FT-120 T LED BAJONET + FT-123 LED BAJONET
+ XXI 1-BAJ-005-005 + ▲



FT-120 T LED BAJONET + ▲



FT-121 T LED BAJONET + FT-123 LED BAJONET
+ XXI 1-BAJ-005-005 + ▲



FT-121 T LED BAJONET + ▲



FT-122 T LED BAJONET + FT-123 LED BAJONET
+ XXI 1-BAJ-005-005 + ▲



FT-122 T LED BAJONET + ▲



FT-088 L PM BAJONET



FT-088 PPM BAJONET PK



MD-036 L BAJONET + ▲



MD-036 L PK BAJONET + ▲



MD-002 L BAJONET QS075
+ MD-035 S ZP M03 + ▲



MD-002 L BAJONET + ▲



FT-077 LPM BAJONET + number plate light



FT-077 PPM PK BAJONET + number plate light

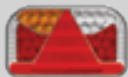

FT-170 NT LED SPKPM BAJONET 5PIN
+ number plate light



FT-170 P NT LED SPK BAJONET 5PIN
+ number plate light



FT-130 NT PM BAJONET + ▲
+ number plate light



FT-130 NT LED BAJONET PK + ▲
+ number plate light



FT-120 LED BAJONET + FT-123 LED BAJONET
+ XXI 1-BAJ-005-005 + ▲ + number plate light



FT-120 LED BAJONET + ▲ + number plate light



FT-121 LED BAJONET + FT-123 LED BAJONET
+ XXI 1-BAJ-005-005 + ▲ + number plate light



FT-121 LED BAJONET + ▲ + number plate light



FT-122 LED BAJONET + FT-123 LED BAJONET
+ XXI 1-BAJ-005-005 + ▲ + number plate light



FT-122 LED BAJONET + ▲ + number plate light



FT-110 LED BAJONET + FT-111 LED BAJONET
+ XXI 1-BAJ-005-005 + ▲ + number plate light



FT-110 LED BAJONET + ▲ + number plate light



FT-113 LED BAJONET + FT-111 LED BAJONET
+ XXI 1-BAJ-005-005 + ▲ + number plate light



FT-113 LED BAJONET + ▲ + number plate light

TYP-XXI3-GN- 12V

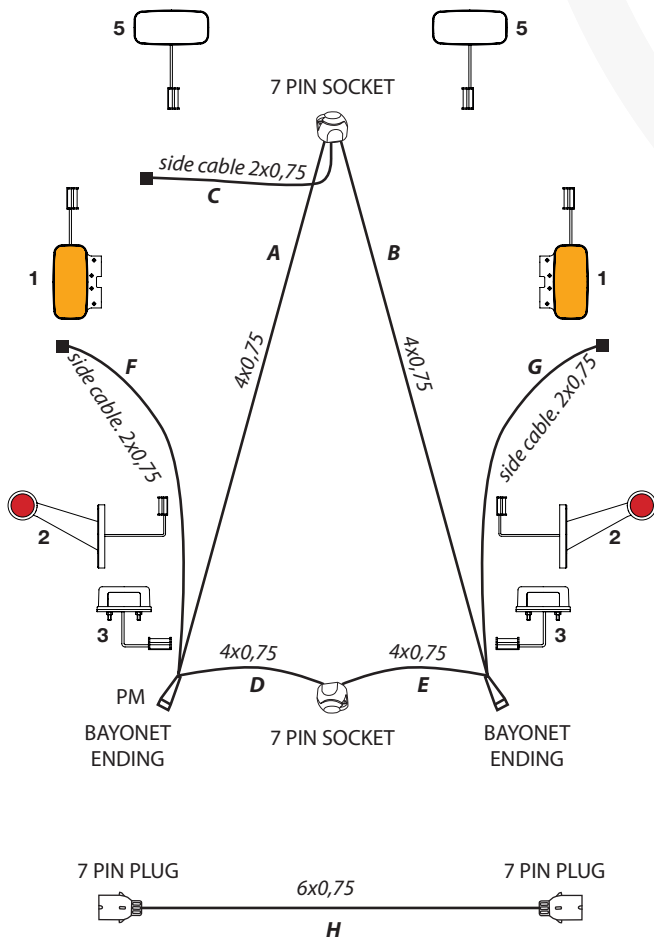

Code	XXI3-GN-
	Length
A	
B	
C	
D	
E	
F	
G	
Code	WTY 7 PIN - ...- WTY 7 PIN
H	

• The wire length is possible to be customized as required •



ORDINAL	PRODUCTS	PAGE
5	front clearance lights	p. 25
1	side clearance lights	p. 26
2	side markers	p. 27
3	number plate lights	p. 28

LEFT

RIGHT

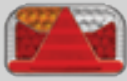

FT-170 L TB LED SPK BAJONET 5 PIN

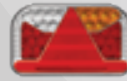

FT-170 P TB LED SPK BAJONET 5 PIN

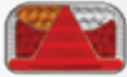

FT-170 L TD LED SPK BAJONET 5 PIN

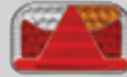

FT-170 P NT LED SPK BAJONET 5 PIN



FT-130 PM PK LED BAJONET + ▲



FT-130 PK LED BAJONET + ▲



FT-120 T LED BAJONET + ▲



FT-120 T LED BAJONET + ▲



FT-121 T LED BAJONET + ▲



FT-121 T LED BAJONET + ▲



FT-122 T LED BAJONET + FT-123 LED BAJONET + XX1 1-BAJ-005-005 + ▲



FT-122 T LED BAJONET + ▲



MD-036 L PK BAJONET + ▲



MD-036 L PK BAJONET + ▲



MD-002 L BAJONET QS075 MD-035 S ZP M03 + ▲



MD-002 L BAJONET + ▲



FT-077 LPM PK BAJONET + number plate light



FT-077 PPM PK BAJONET + number plate light



FT-170 L NT LED SPK BAJONET 5 PIN + number plate light



FT-170 P NT LED SPK BAJONET 5 PIN + number plate light



FT-130 NT PM PK LED BAJONET + ▲ + number plate light



FT-130 NT LED BAJONET PK + ▲ + number plate light



FT-120 LED BAJONET + ▲ + number plate light



FT-120 LED BAJONET + ▲ + number plate light



FT-121 LED BAJONET + ▲ + number plate light



FT-121 LED BAJONET + ▲ + number plate light



FT-122 LED BAJONET + ▲ + number plate light



FT-122 LED BAJONET + ▲ + number plate light



FT-110 LED BAJONET + ▲ + number plate light



FT-110 LED BAJONET + ▲ + number plate light



FT-113 LED BAJONET + ▲ + number plate light



FT-113 LED BAJONET + ▲ + number plate light

FRONT CLEARANCE LIGHTS



FT-001 B LED *QS075



FT-019 B LED *QS075



FT-001 B I LED *QS075



FT-019 B+K LED *QS075



FT-001 B II LED *QS075



FT-020 B LED *QS075



FT-001 B III LED *QS075



FT-020 B+K LED *QS075



FT-001 B IV LED *QS075



FT-012 B LED *QS075



MD-013 B LED *QS075



FT-012 B+K LED *QS075



MD-013 B+K LED *QS075



FT-015 B LED *QS075



FT-004 B LED *QS075



FT-015 B+K LED *QS075



FT-004 B+K LED *QS075



FT-070 B LED *QS075



FT-060 B LED *QS075



FT-070 B+K LED *QS075



FT-060 L B+K LED *QS075



FT-025 B LED *QS075



FT-060 P B+K LED *QS075



FT-029 B LED *QS075



FT-027 B LED *QS075



FT-001 B LED *QS075



FT-045 B LED *QS075



FT-001 B I LED *QS075



FT-017 B LED *QS075



FT-001 B II LED *QS075



FT-017 B+K LED *QS075



FT-001 B III LED *QS075



FT-018 B LED *QS075



FT-001 B IV LED *QS075

SIDE CLEARANCE LAMPS

	FT-001 Z LED *QS075		FT-019 Z LED *QS075
	FT-001 Z I LED *QS075		FT-019 Z+K LED *QS075
	FT-001 Z II LED *QS075		FT-020 Z LED *QS075
	FT-001 Z III LED *QS075		FT-020 Z+K LED *QS075
	FT-001 Z IV LED *QS075		FT-012 Z LED *QS075
	MD-013 B LED *QS075		FT-012 Z+K LED *QS075
	MD-013 B+K LED *QS075		FT-015 Z LED *QS075
	FT-004 B LED *QS075		FT-015 Z+K LED *QS075
	FT-004 B+K LED *QS075		FT-070 Z LED *QS075
	FT-060 Z LED *QS075		FT-070 Z+K LED *QS075
	FT-060 Z+K LED *QS075		FT-025 Z LED *QS075
	FT-027 B LED *QS075		FT-001 Z LED *QS075
	FT-045 B LED *QS075		FT-001 Z I LED *QS075
	FT-017 Z LED *QS075		FT-001 Z II LED *QS075
	FT-017 Z+K LED *QS075		FT-001 Z III LED *QS075
	FT-018 Z LED *QS075		FT-001 Z IV LED *QS075
	FT-029 Z LED *QS075		

SIDE MARKERS



FT-009 A LED *QS075



FT-024 *QS075



FT-009 B LED *QS075



FT-024 I *QS075



FT-009 C LED *QS075



FT-024 II *QS075



FT-009 D LED *QS075



FT-024 III *QS075



FT-009 E LED *QS075



FT-024 IV *QS075



FT-009 F LED *QS075



FT-033 A *QS075



FT-140 A L LED *QS075



FT-033 B *QS075



FT-140 A P LED *QS075



FT-033 C *QS075



FT-140 F L LED *QS075



FT-033 D *QS075



FT-140 F P LED *QS075



FT-033 E *QS075



FT-140 W L LED *QS075



FT-033 F *QS075



FT-140 W P LED *QS075



FT-038 LED *QS075



FT-038 I LED *QS075



FT-038 II LED *QS075

NUMBER PLATE LIGHT



FT-022 *QS075



FT-022/A *QS075



FT-022/1 *QS075



FT-022/1/A *QS075



FT-037 *QS075



FT-037/1 *QS075



FT-037/P *QS075



FT-037/1/P *QS075



FT-016 LED *QS075 M05



FT-016/1 LED *QS075 M05



FT-016/A LED *QS075 M05



FT-016/1/A LED *QS075 M05



FT-031 LED *QS075



FT-031 A LED *QS075



FT-026 LED *QS075



FRONT REFLECTORS



DOB-034 B



DOB-035 B



FT-46x26 B



DOB-039A B



DOB-039 B



DOB-032 B



DOB-033 B



DOB-42 B



DOB-42A B



DOB-43 B



DOB-034 Z



DOB-035 Z

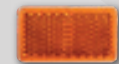

FT-46x26 Z



DOB-039A Z



DOB-039 Z



DOB-032 Z



DOB-033 Z



DOB-42 Z



DOB-42A Z

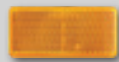

DOB-43 Z

BACK REFLECTORS

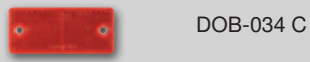

DOB-034 C

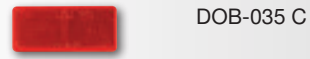

DOB-035 C



FT-46x26 C

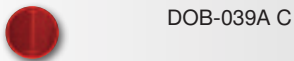

DOB-039A C

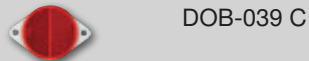

DOB-039 C

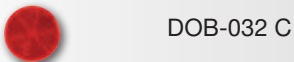

DOB-032 C

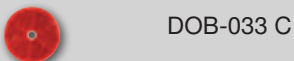

DOB-033 C

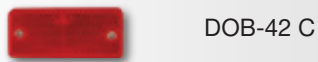

DOB-42 C



DOB-42A C



DOB-43 C

TRIANGLE REFLECTORS

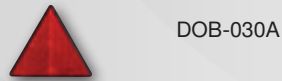

DOB-030A



DOB-031

ACCESSORIES



WTY 7 PIN



WTY 13 PIN



WTY GNIAZDO 7 PIN



WTY GNIAZDO 13 PIN



WTY ADAPTER 7/13 PIN

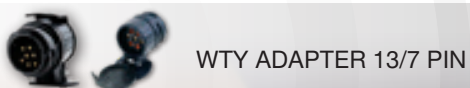

WTY ADAPTER 13/7 PIN

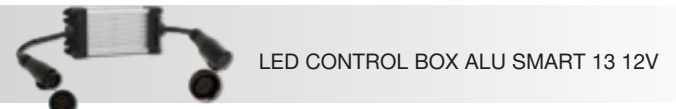

LED CONTROL BOX ALU SMART 13 12V



LED CONTROL BOX ALU SMART 7 12V



LED CONTROL BOX ALU SMART 12V BW



KLIN SET

IIIA - PM -

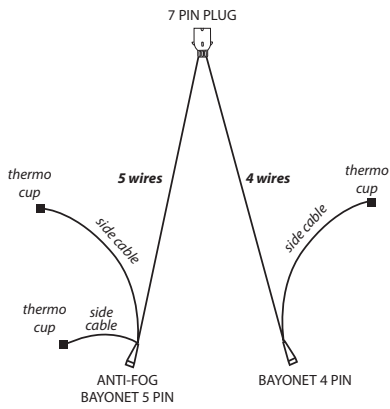

VIA - PM - COF -

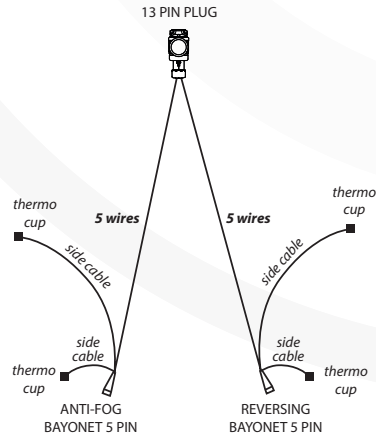

XI -

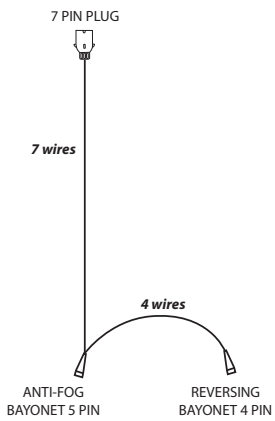

XIA -

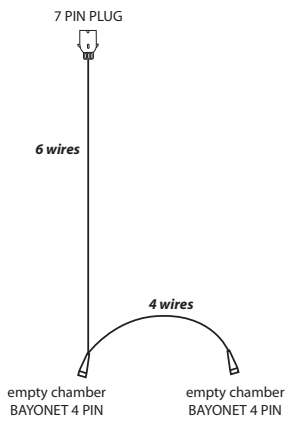

XI1 -

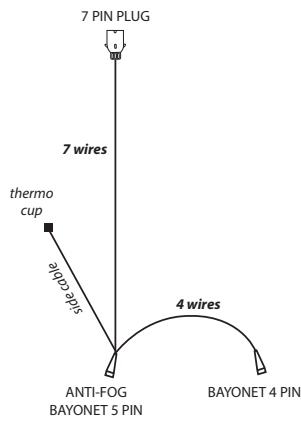

XI1A -

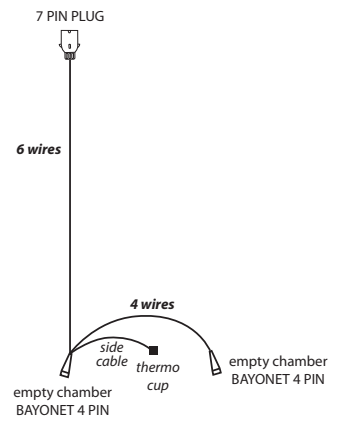

XI2 -

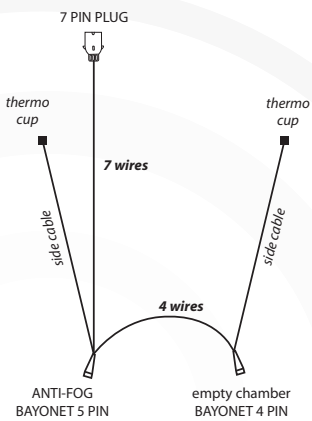

XI2A -

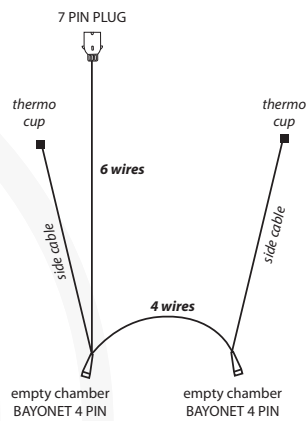

XII -

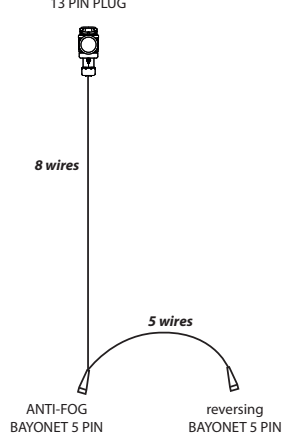

XII1 -

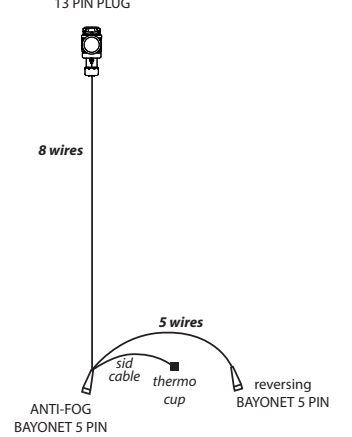

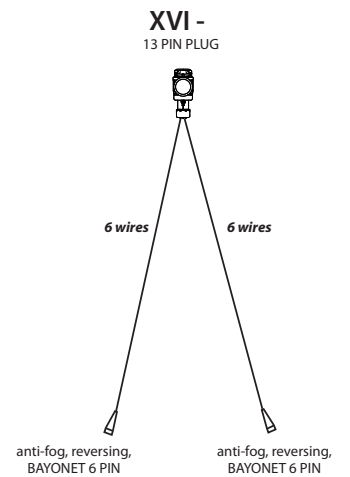
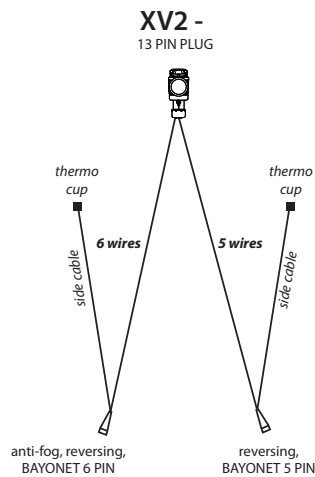
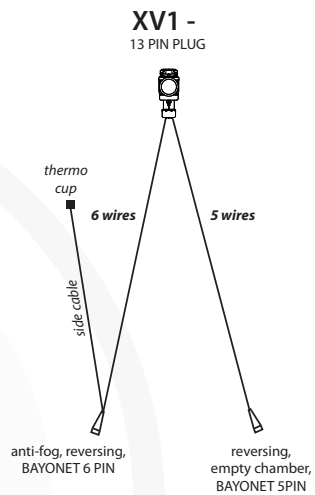
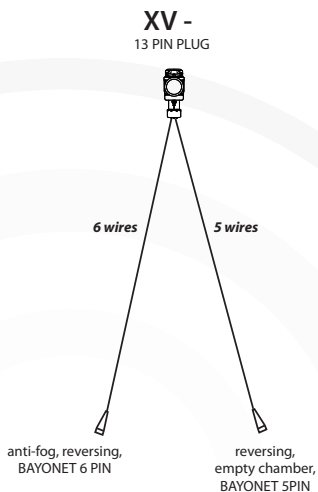
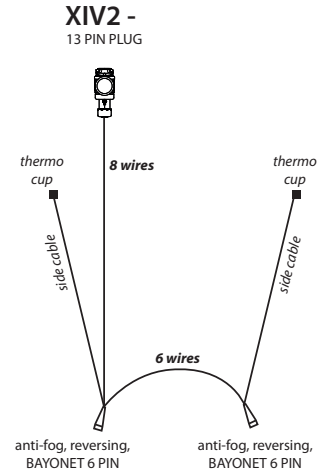
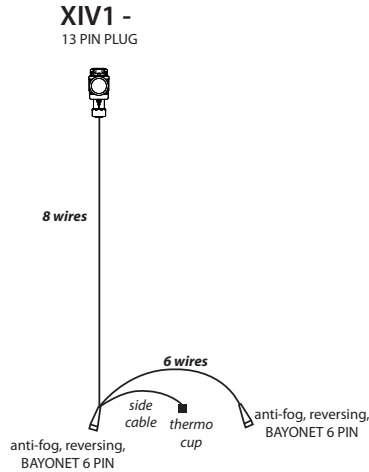
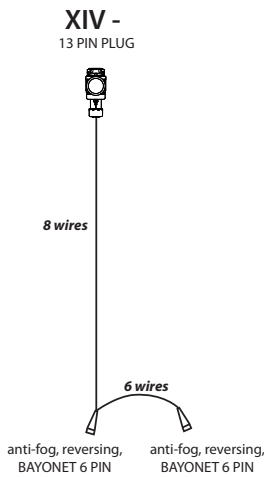
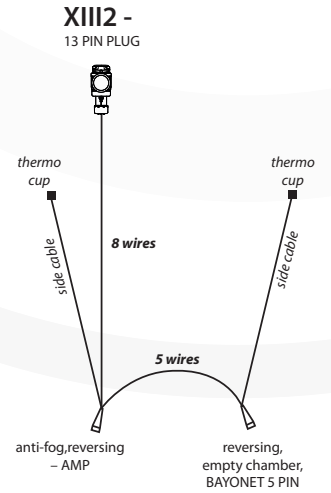
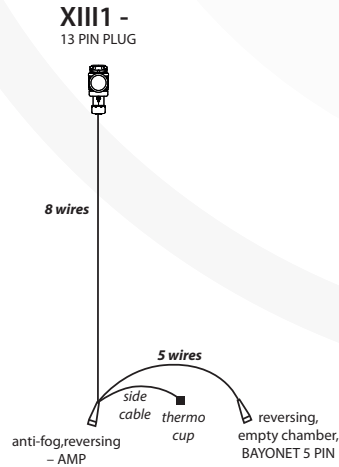
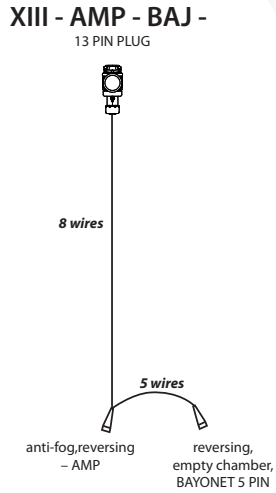
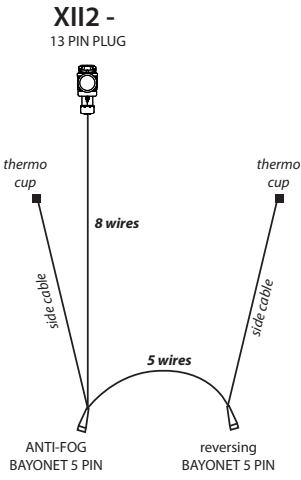

XVII1 -
13 PIN PLUG

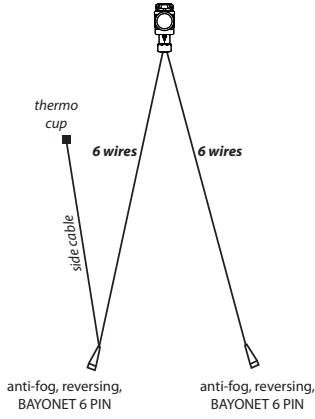

XVII2 -
13 PIN PLUG

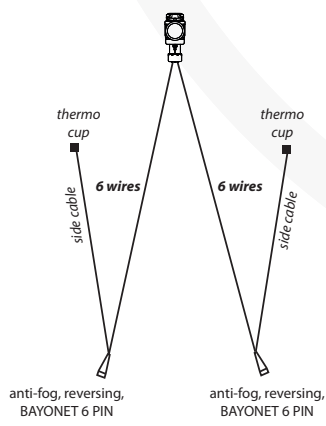

XVII -

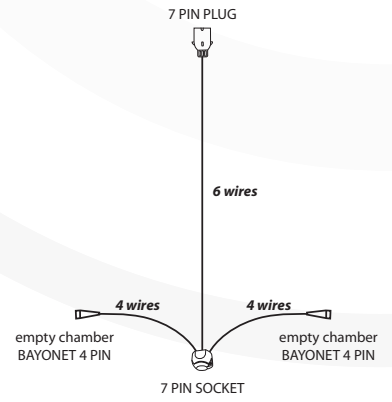

XVII1 -

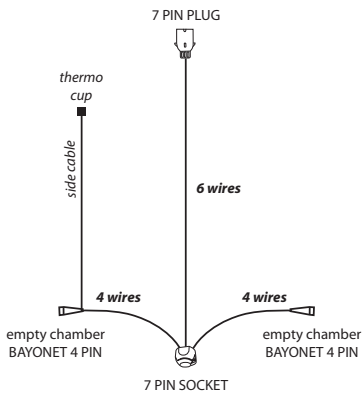

XVII2 -

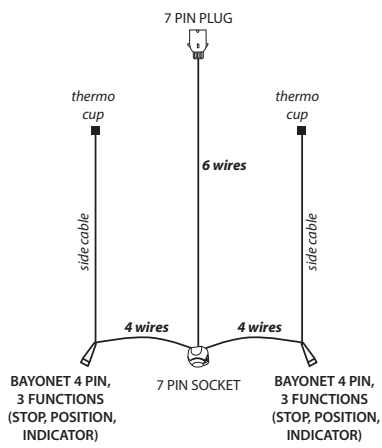

XVII2 -

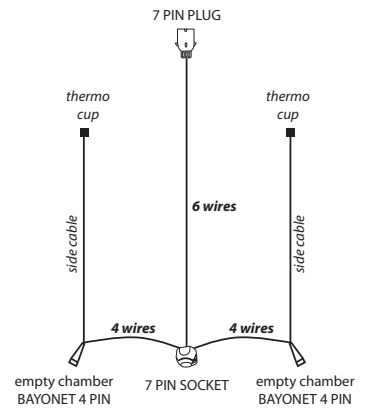

XVII2 - 2 BAJ -

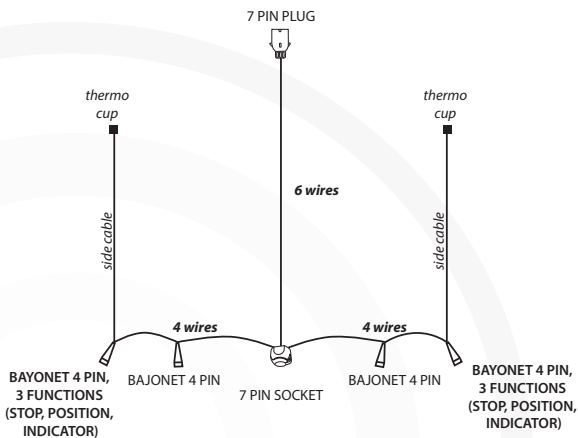

XIX -

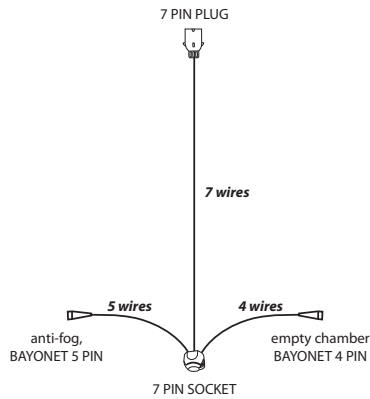

XIX1 -

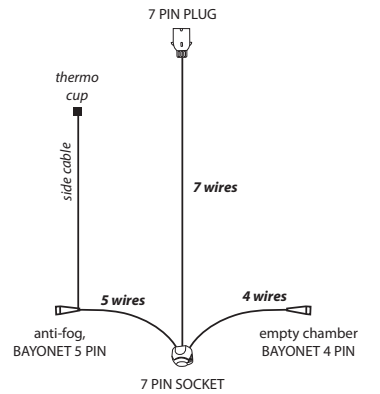

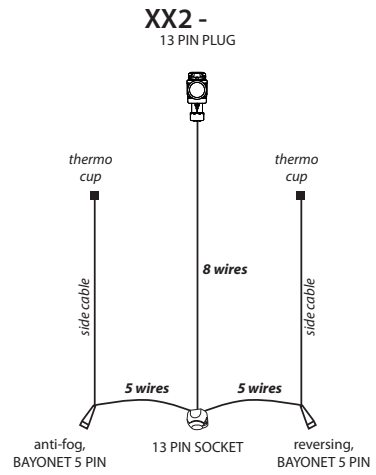
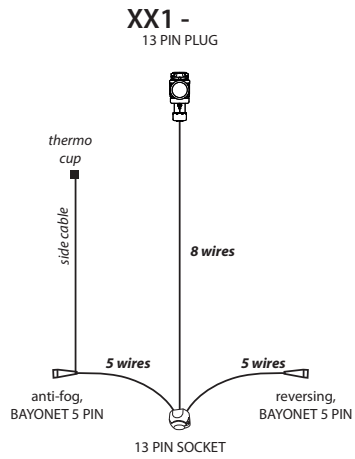
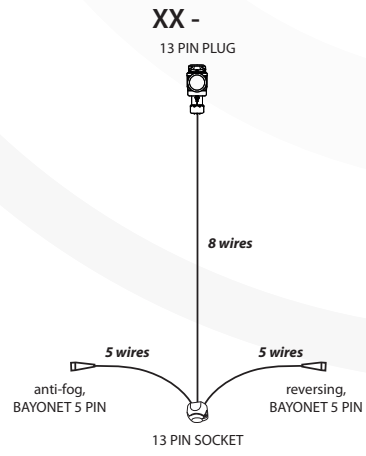
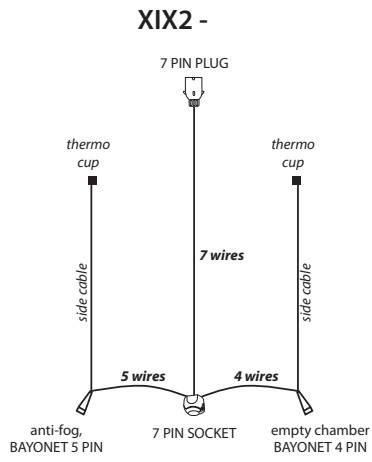

EXTENSION CABLES FOR SEPARABLE WIRES

IXC

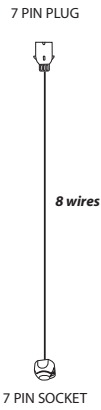

IXA



IXB

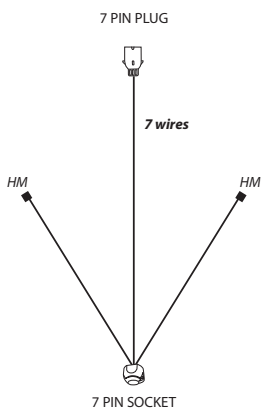

IX

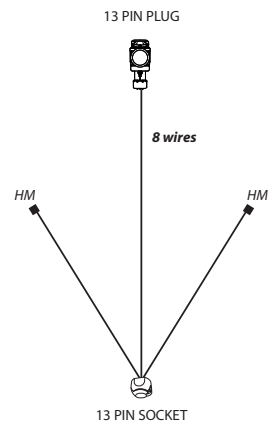

WTY 7 PIN WTY 7 PIN



WTY 13 PIN WTY 13 PIN

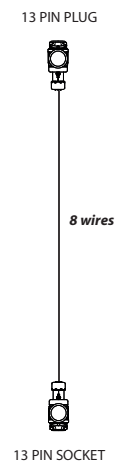

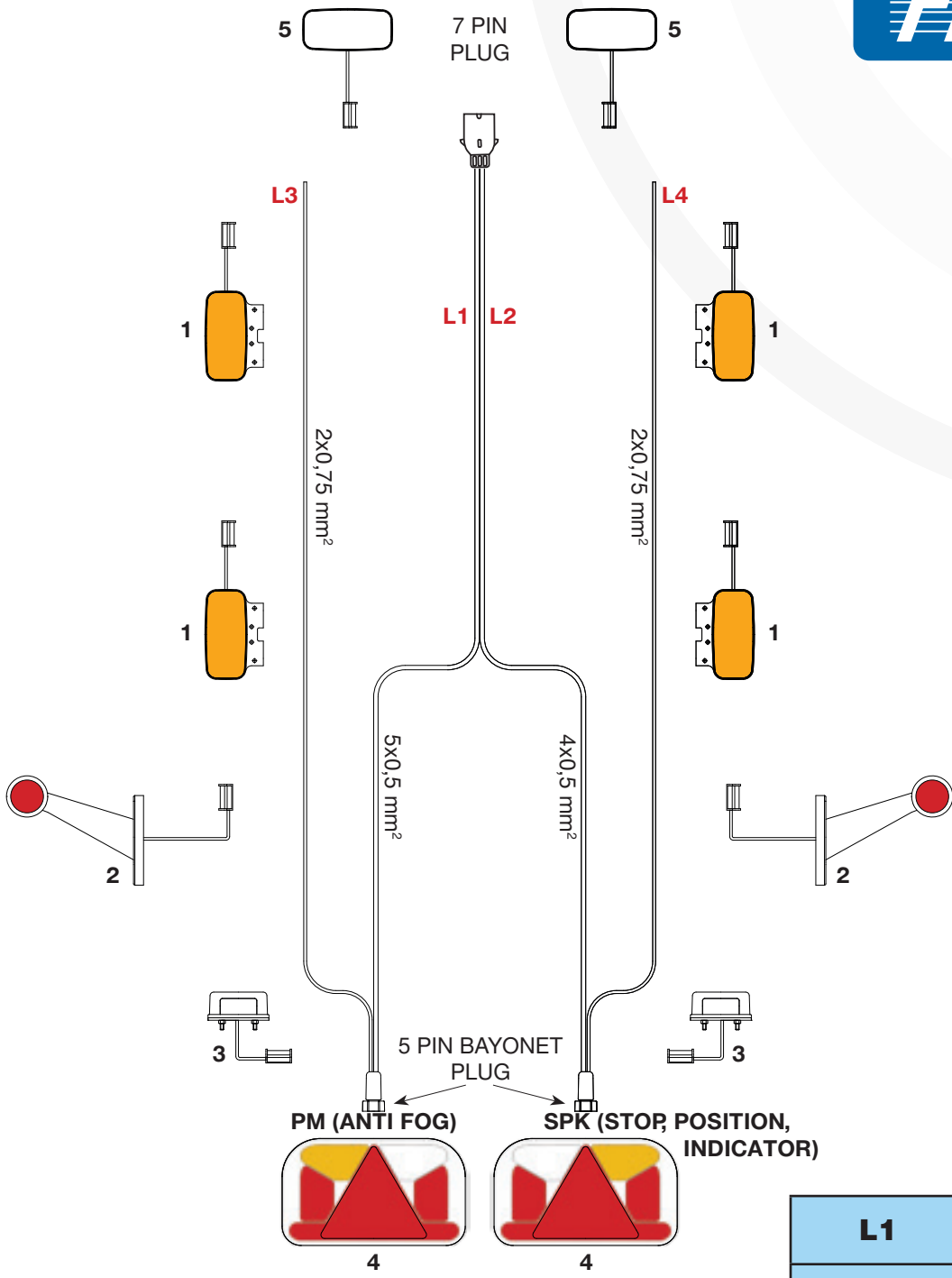

• The wire length is possible to be customized as required •

L1	
L2	
L3	
L4	
1	
2	
3	
4	
5	

NOTES

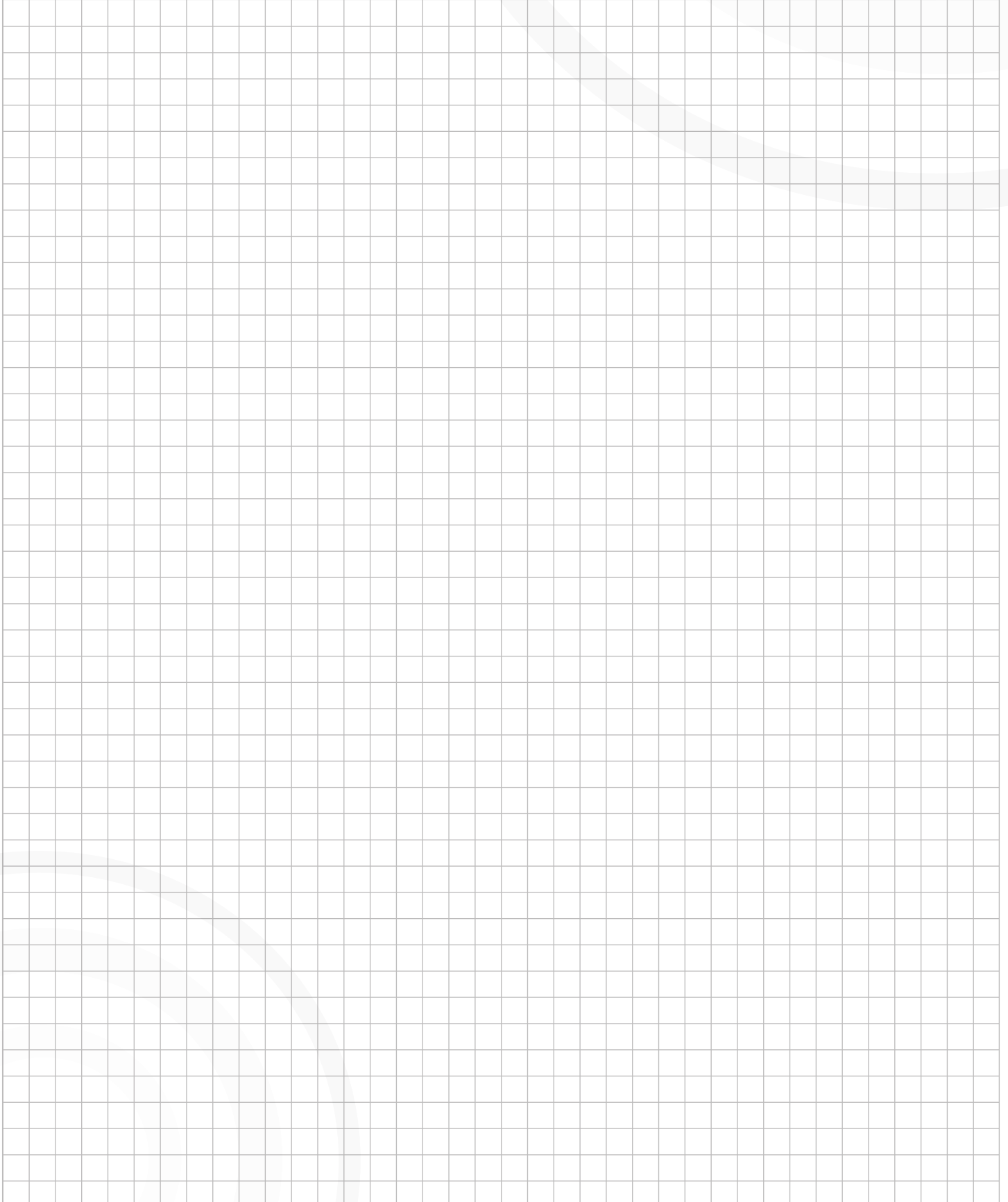
A large grid of small squares, intended for writing notes. The grid is composed of 20 columns and 30 rows of squares.

NOTES

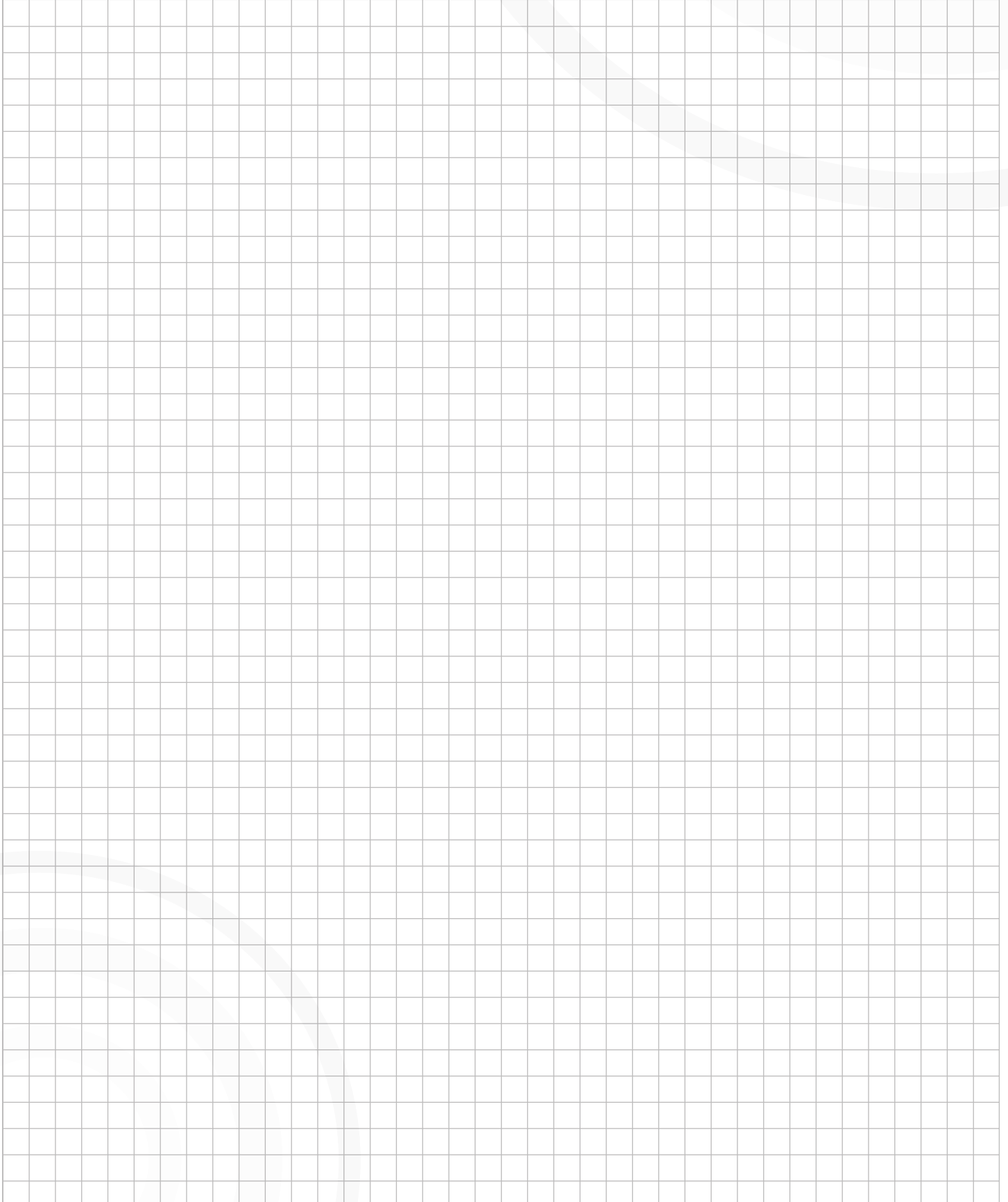
A large grid of small squares, intended for writing notes. The grid is composed of 20 columns and 30 rows of squares.



HEADQUARTERS: FRISTOM
Spółka z ograniczoną odpowiedzialnością Sp. k.
POLAND, Przemysłowa 5 Street, 86-014 Sicienko

SALES OFFICE: FRISTOM
Spółka z ograniczoną odpowiedzialnością Sp. k.
POLAND, Grunwaldzka 207A Street , 85-451 Bydgoszcz
tel. +48 52 360 90 51, fax +48 52 327 75 41
www.fristom.com.pl